

Axio Lab.A1

Top of the class in complex applications

The Axio Lab.A1 upright polarization microscope impresses with top marks when it comes to ergonomics, functionality, operating concept and optical performance. This is an instrument for polarization that has been rigorously designed to meet the demands of education and routine work.

Polarization microscopy is all about arriving at reliable statements directly, precisely and in a reproducible way. The Axio Lab.A1 makes this possible and provides answers to questions relating to refractive indices, cleavages, double refraction, extinction angles, optical path differences and the number and angle of optical axes.

Key features:

- ZEISS ICS optics
- wide range of accessories
- conoscopy stand to meet the highest demands
- logical coupling of analyzer and Bertrand lens



**Polarization that's made to measure.
Impressive performance, convincing price.**



We make it visible.

Impressive functionality and excellent optics

The Axio Lab.A1 offers an impressive range of options. This, together with the Carl Zeiss quality promise, guarantees efficient working at the highest level!

ICS optics

With the Axio Lab.A1, users have a large selection of ICS objectives available to them, such as the EC Plan Neofluar Pol or Achromplan Pol. All these objectives are strain-free to ensure that you can achieve precise results. You will benefit from the particularly large field of view (field of view number 20 or 22) and be able to take in the essential details from your analyses at a glance.

Illumination

The patented transmitted light source offers illumination of sufficient intensity, especially for critical applications such as darkfield, with a service life of 4,000 hours. LED lamps can also be incorporated as a particularly energy-saving variant, enabling a service life of 10,000 hours to be achieved, with constant color temperature and low energy consumption included.

Intelligent operation

The analyzer and Bertrand lens have been integrated into the instrument and logically coupled. If the Bertrand lens is swung into the beam path, this coupling ensures that the analyzer swings into the beam path too. This increases both operating convenience and the certainty that all settings have been optimally adjusted to the application in question.



The ICS objective range – brilliant, strain-free optics.

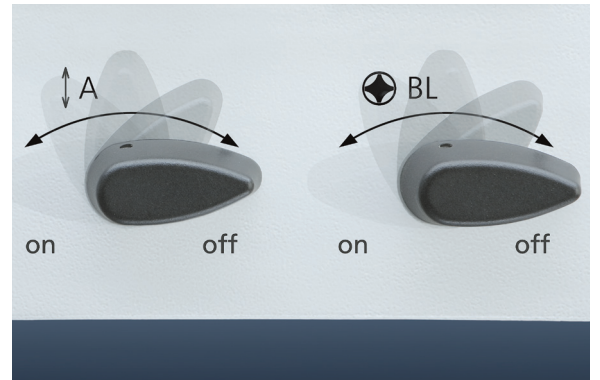

The analyzer and Bertrand lens have been mechanically coupled.

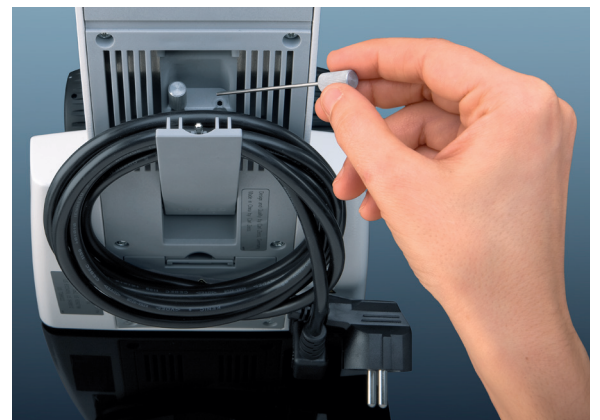

Everything to hand: tool holder at the back of the microscope.

Polarization with a full range of applications

Whether it is used as a teaching, laboratory or routine microscope, the Axio Lab.A1 offers you the best conditions for analyses in the fields of geology, mineralogy, materials research and environmental analysis.

Range of accessories

Various auxiliary objects and measuring compensators extend the broad range of applications that can be covered with the Axio Lab.A1. The instrument has been equipped with fixed and rotatable compensators, making it ideal for contrasting large and small path differences, as well as for determining the relative optical character of, for example, fibrous substances.

360° polarization rotary stage

The rotary stage is graduated and features a vernier for measuring cleavages and extinction angles. There are also clips to ensure that the sample is held securely on the stage. An object guide for the polarization rotary stage is available as an option.

Ergonomics

The Axio Lab.A1 offers a complete range of ergonomic phototubes which make working on the instrument on a day-to-day basis much more comfortable. Small, carefully considered details, such as storage for the cable and tools, and a secure place to keep auxiliary objects in the stand, ensure greater convenience in your everyday work.



Auxiliary objectives and measuring compensators.

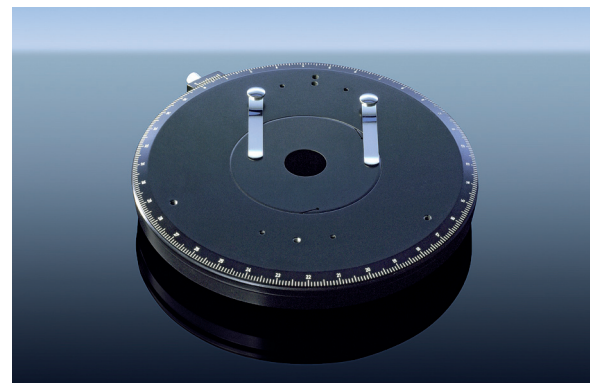

Polarization rotary stage with clips and vernier.

The Axio Lab.A1 for polarization is the perfect instrument for a wide range of applications in geology and mineralogy, as well as in fiber and textiles science, the plastics industry and many more fields besides.

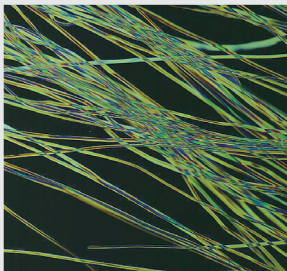

Silk, polarization contrast.

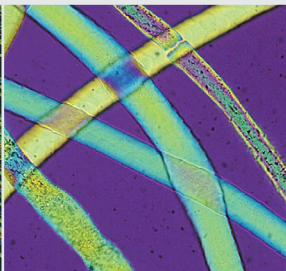

Silk, polarization contrast, compensator λ .

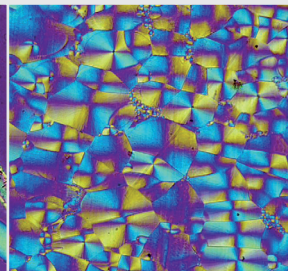

Amphibole eclogite, thin section, polarization contrast.

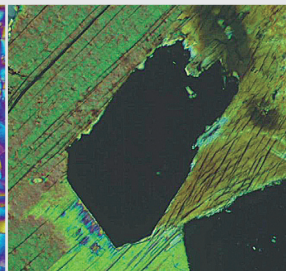

Feldspar crystal, linear polarized light, dark setting.

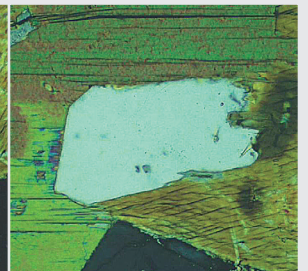

Feldspar crystal, linear polarized light, light setting.

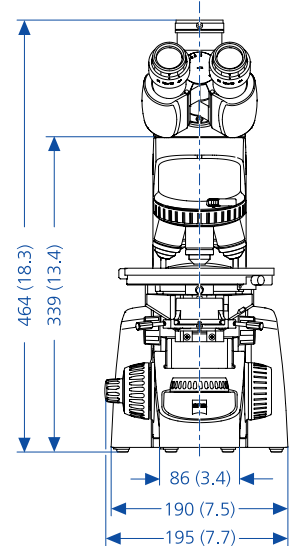
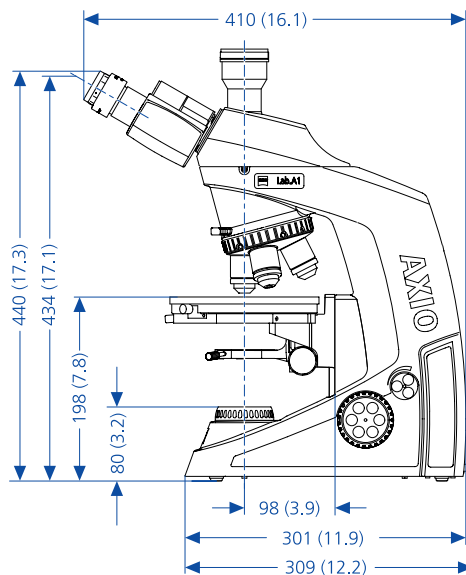

Axio Lab.A1 – Technical Data

Stand	Upright Axio Lab.A1 microscope stand with integrated transmitted light illumination	Upright Axio Lab.A1 microscope stand with integrated transmitted light illumination
Focus drive	Manual, coaxial coarse/fine drive, 30 mm travel range	Manual, coaxial coarse/fine drive, 30 mm travel range
Illumination	Halogen reflector lamp HAL 35 / 12V 35W optional LED	Halogen reflector lamp HAL 35 / 12V 35W optional LED
Nosepiece	4 pos. centerable, for brightfield and polarization, M27	4 pos. centerable, for brightfield and polarization, M27
Analyzer	Optional	Included with stand, rotatable
Bertrand system	–	Included with stand, focusable
Depolarizer	Optional	Included with stand
Power supply unit	Built-in power supply 12V DC 50W stabilized, 100...240V AC/50...60Hz/110VA	Built-in power supply 12V DC 50W stabilized, 100...240V AC/50...60Hz/110VA
Specimen stage	360° Pol rotary stage, with clips and vernier Hard-anodized surface, with 2 spring clips	360° Pol rotary stage, with clips and vernier Hard-anodized surface, with 2 spring clips
Eyepieces	E-PL 10x/20 Br. foc. PL 10x/22 Br. foc. PL 10x/22 Br.I foc. Pol PL 16x/16 Br. foc.	E-PL 10x/20 Br. foc. PL 10x/22 Br. foc. PL 10x/22 Br.I foc. Pol PL 16x/16 Br. foc.
Camera	AxioCam ERc 5s Sensor: 5 MP CMOS sensor Resolution: 2560 (H) x 1920 (V) = 5.0 megapixels Pixel size: 2.2 µm x 2.2 µm Interfaces: 1x SD card slot, 1x mini USB 2.0, 1x AV (S-Video), 1x DVI (HDMI) Optical connection: C-mount	AxioCam ERc 5s Sensor: 5 MP CMOS sensor Resolution: 2560 (H) x 1920 (V) = 5.0 megapixels Pixel size: 2.2 µm x 2.2 µm Interfaces: 1x SD card slot, 1x mini USB 2.0, 1x AV (S-Video), 1x DVI (HDMI) Optical connection: C-mount

Carl Zeiss MicroImaging GmbH

07740 Jena, Germany

Industrial | Göttingen Location

Phone : +49 551 5060 660

Telefax: +49 551 5060 464

E-Mail : micro@zeiss.de

www.zeiss.de/AxioLab-Pol